

## L3 24-Port 10/100/1000T 802.3at PoE+ 4-Port 10G SFP+ Managed Switch



### 10G Ethernet Switch Solution for SMBs

PLANET GS-5220 24-port 802.3at PoE+ Layer 3 Managed Switch supports both **IPv4 and IPv6 protocols**, and **hardware Layer 3 static routing** capability. It complies with **IEEE 802.3at Power over Ethernet Plus (PoE+)**, and is equipped with **24 10/100/1000BASE-T** Gigabit Ethernet ports, **4 shared Gigabit SFP ports** and **4 10G SFP+ uplink ports**. Its 24 Gigabit Ethernet ports are integrated with 802.3at PoE+ injector function.

The GS-5220 can handle extremely large amounts of data in a secure topology linking to deployed Power over Ethernet networks, data center/service provider backbone or high capacity servers. It can work with a 10Gbps SFP+ server adapter to help SMBs build the 10Gbps Ethernet network providing 10Gbps NAS (Network Attached Storage) or heavy transmission of video streaming service.

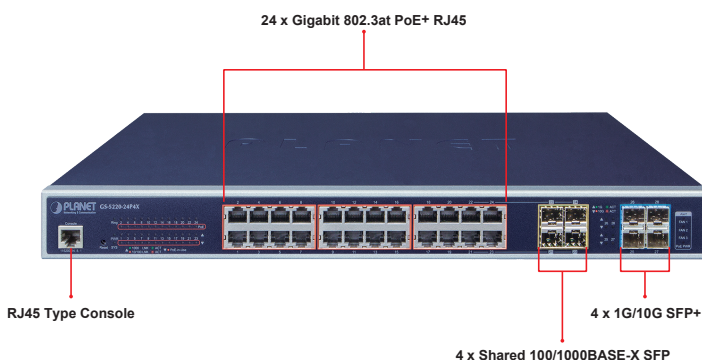

### Layer 3 Routing Support

The GS-5220 enables the administrator to conveniently boost network efficiency by configuring Layer 3 IPv4/IPv6 VLAN static routing manually, and the **OSPFv2** (Open Shortest Path First) settings automatically. The OSPF is an interior dynamic routing protocol for autonomous system based on link state. The protocol creates a database for link state by exchanging link states among Layer 3 switches, and then uses the Shortest Path First algorithm to generate a route table based on that database.

### Physical Port

- **24 10/100/1000BASE-T** Gigabit Ethernet RJ45 ports with **IEEE 802.3at PoE+** injector function
- **4 100/1000BASE-X mini-GBIC/SFP** combo interfaces with Port-21 to Port-24
- **4 10GBASE-SR/LR SFP+ ports**, compatible with 1000BASE-SX/LX/BX SFP
- 1 RJ45 console interface for basic management and setup

### Power over Ethernet

- Complies with IEEE 802.3at PoE+/end-span PSE
- Up to 24 IEEE 802.3af/802.3at devices powered
- Supports PoE power up to 36 watts for each PoE port
- Auto detects powered device (PD)
- Circuit protection prevents power interference between ports
- Remote power feeding up to 100M
- PoE Management
  - Total PoE power budget control
  - Per port PoE function enable/disable
  - PoE port power feeding priority
  - Per PoE port power limit
  - PD classification detection
- Intelligent PoE features
  - Temperature threshold control
  - PD alive check
  - PoE schedule
  - PD scheduled power recycling

### Layer 2 Features

- Prevents packet loss with back pressure (half-duplex) and IEEE 802.3x pause frame flow control (full-duplex)
- High performance of Store-and-Forward architecture and runt/CRC filtering eliminates erroneous packets to optimize the network bandwidth
- Storm Control support
  - Broadcast/Multicast/Unknown unicast
- Supports **VLAN**
  - IEEE 802.1Q tagged VLAN
  - Up to 4K VLANs groups, out of 4095 VLAN IDs
  - Supports provider bridging (VLAN Q-in-Q, IEEE 802.1ad)
  - Private VLAN Edge (PVE)
  - Protocol-based VLAN

**Redundant Ring, Fast Recovery for Critical Network Applications**

The GS-5220 supports redundant ring technology and features strong, rapid self-recovery capability to prevent interruptions and external intrusions. It incorporates advanced ITU-T **G.8032 ERPS (Ethernet Ring Protection Switching)** technology and Spanning Tree Protocol (802.1w RSTP) into customer's network to enhance system reliability and uptime in harsh environments. In a network, the recovery time could be **less than 10ms** to quickly bring the network back to normal operation.

**Network with Cybersecurity Helps Minimize Security Risks**

The GS-5220 comes with enhanced cybersecurity to fend off cyberthreats and cyberattacks. It supports SSHv2 and TLSv1.2 protocols to provide strong protection against advanced threats. Served as a key point to transmit data over a long-distance fiber optic cable to customer's critical equipment in a business network, the cybersecurity feature of the GS-5220 protects the switch management and enhances the security of the mission-critical network without any extra deployment cost and effort.



**Redundant AC/DC Power Supply to Ensure Continuous Operation**

The GS-5220-24PL4XR is particularly equipped with one 100~240V AC power supply unit and one 36~60V DC power supply unit to provide an enhanced reliable and scalable redundant power supply. The continuous power system is specifically designed to fulfill the demands of high-tech facilities requiring the highest power integrity. With the 36~60V DC power supply, the GS-5220-24PL4XR is able to act as a telecom-level device that can be located in the electronic room.

**Convenient and Smart ONVIF Devices with Detection Feature**

PLANET has newly developed an awesome feature -- ONVIF Support -- which is specifically designed for co-operating with Video IP Surveillances. From the GS-5220 PoE+ series GUI, clients just need one click to search and show all of the ONVIF devices via network application. In addition, clients can upload floor images onto the switch allowing deployed surveillance devices to be located for easier inspection and planning. Moreover, clients can get real-time surveillance's information and online/offline status, and also allows PoE reboot control from GUI.

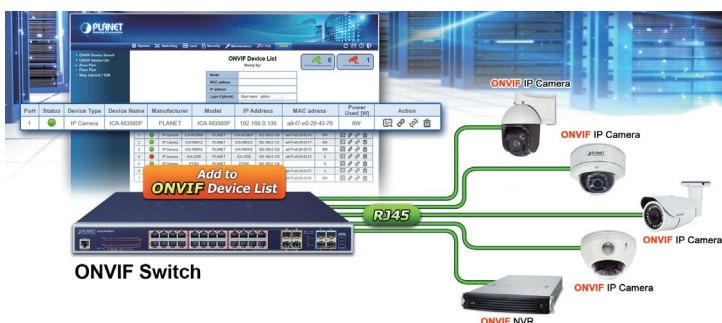

- MAC-based VLAN
- Voice VLAN
- GVRP (GARP VLAN Registration Protocol)
- Supports Spanning Tree Protocol
  - IEEE 802.1D Spanning Tree Protocol (STP)
  - IEEE 802.1w Rapid Spanning Tree Protocol (RSTP)
  - IEEE 802.1s Multiple Spanning Tree Protocol (MSTP), spanning tree by VLAN
  - BPDU Guard
- Supports **Link Aggregation**
  - 802.3ad Link Aggregation Control Protocol (LACP)
  - Cisco ether-channel (static trunk)
  - Maximum 14 trunk groups with 8 ports for each trunk group
  - Up to 88Gbps bandwidth (full duplex mode)
- Provides port mirror (many-to-1)
- Port mirroring to monitor the incoming or outgoing traffic on a particular port
- Loop protection to avoid broadcast loops
- Link Layer Discovery Protocol (LLDP) and LLDP-MED
- Supports G.8032 ERPS (Ethernet Ring Protection Switching)

**Layer 3 Features**

- Supports maximum 128 static routes and route summarization
- IP dynamic routing protocol supports OSPFv2
- Routing interface provides per VLAN routing mode

**Quality of Service**

- Ingress Shaper and Egress Rate Limit per port bandwidth control
- 8 priority queues on all switch ports
- Traffic classification
  - IEEE 802.1p CoS
  - TOS/DSCP/IP precedence of IPv4/IPv6 packets
  - IP TCP/UDP port number
  - Typical network application
- Strict priority and Weighted Round Robin (WRR) CoS policies
- Supports QoS and In/Out bandwidth control on each port
- Traffic-policing on the switch port
- DSCP remarking

**Multicast**

- Supports IPv4 IGMP snooping v1, v2 and v3
- Supports IPv6 MLD snooping v1 and v2
- Querier mode support

### Flexible and Extendable 10Gbps Ethernet Solution

10Gbps Ethernet is a big leap in the evolution of Ethernet. Each of the SFP+ ports supports dual speed and 10GBASE-SR/LR, meaning the administrator now can flexibly choose the suitable SFP+ transceiver according to the transmission distance or the transmission speed required to extend the network efficiently. With its 4-port, 10Gbps Ethernet link capability, the GS-5220 provides broad bandwidth and powerful processing capacity.

### Centralized Power Management for Gigabit Ethernet PoE Networking

To fulfill the needs of higher power required PoE network applications with Gigabit speed transmission, the GS-5220 features IEEE 802.3at PoE+ that combines up to 36 watts of power output and data per port over one Cat5E/6 Ethernet cable. It is designed specifically to meet the demand of higher power consuming network PD (powered device) such as IR, PTZ, speed dome cameras or even box-type IP camera with a built-in fan and heater. Compliant with both 802.3at and 802.3af, it allows more flexibility in power requirement for a variety of PDs.

### Built-in Unique PoE Functions for Surveillance Management

As a managed PoE Switch for surveillance network, the GS-5220 features four special PoE management functions:

- PD alive check
- Scheduled power recycling
- PoE schedule
- PoE usage monitoring

### Intelligent Powered Device Alive Check

The GS-5220 can be configured to monitor connected PD status in real time via ping action. Once the PD stops working and has no response, the GS-5220 will resume the PoE port power and bring the PD back to work. It will greatly enhance the network reliability through the PoE port resetting the PD's power source and reduces administrator management burden.

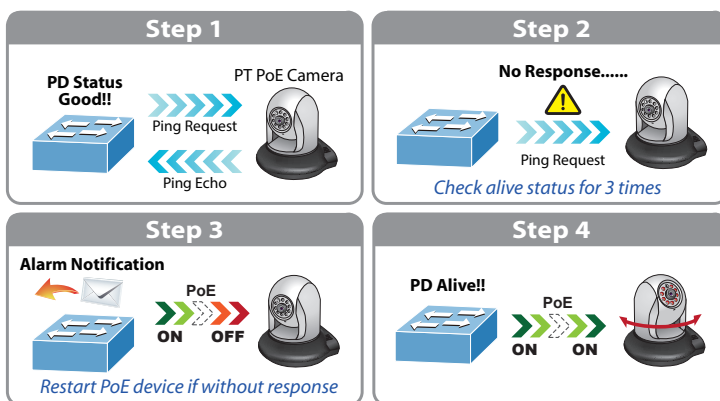

### Scheduled Power Recycling

The GS-5220 allows each of the connected PoE IP cameras to reboot at a specified time each week. Therefore, it will reduce the chance of IP camera crash resulting from buffer overflow.

- IPv4 IGMP snooping port filtering
- IPv6 MLD snooping port filtering
- Multicast VLAN Registration (MVR) support

### Security

- Authentication
  - IEEE 802.1x port-based/MAC-based network access authentication
  - Built-in RADIUS client to cooperate with the RADIUS servers
  - TACACS+ login users access authentication
  - RADIUS/TACACS+ users access authentication
  - Guest VLAN assigns clients to a restricted VLAN with limited services
- Access Control List
  - IP-based Access Control List (ACL)
  - MAC-based Access Control List
- Source MAC/IP address binding
- **DHCP Snooping** to filter untrusted DHCP messages
- **Dynamic ARP Inspection** discards ARP packets with invalid MAC address to IP address binding
- **IP Source Guard** prevents IP spoofing attacks
- IP address access management to prevent unauthorized intruder

### Management

- IPv4 and IPv6 dual stack management
- Switch Management Interfaces
  - Console/Telnet Command Line Interface
  - Web switch management
  - SNMP v1, v2c, and v3 switch management
  - SSHv2, TLSv1.2 secure access
- SNMP Management
  - Four RMON groups (history, statistics, alarms, and events)
  - SNMP trap for interface Link Up and Link Down notification
- **IPv6** IP address/NTP/DNS management
- Built-in Trivial File Transfer Protocol (TFTP) client
- BOOTP and DHCP for IP address assignment
- System Maintenance
  - Firmware upload/download via HTTP/TFTP
  - Reset button for system reboot or reset to factory default
  - Dual images
- DHCP Relay
- DHCP Option 82
- DHCP Server
- User Privilege levels control

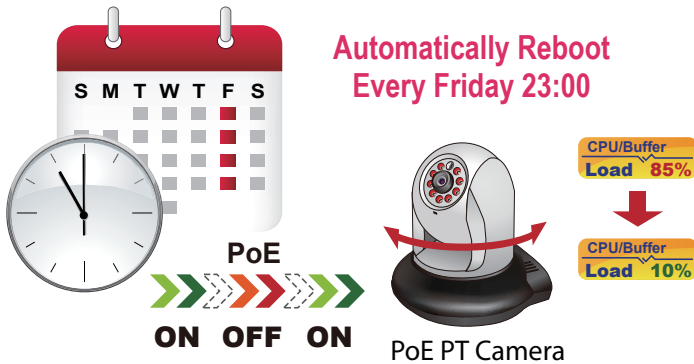

**PoE Schedule for Energy Savings**

Besides IP surveillance, the GS-5220 is certainly applicable to construct any PoE network including VoIP and wireless LAN. Under the trend of energy saving worldwide and contributing to environment protection on the Earth, the GS-5220 can effectively control the power supply besides its capability of giving high watts power. The “**PoE schedule**” function helps you to enable or disable PoE power feeding for each PoE port during specified time intervals and it is a powerful function to help SMBs or enterprises save power and money.

- NTP (Network Time Protocol)
- Network Diagnostic
  - SFP-DDM (Digital Diagnostic Monitor)
  - ICMPv6/ICMPv4 remote ping
  - Cable diagnostic technology provides the mechanism to detect and report potential cabling issues
- SMTP, syslog and SNMP trap remote alarm
- Local system Log
- PLANET Smart Discovery Utility for deployment management
- Smart fan with speed control

**Redundant Power System (GS-5220-24PL4XR)**

- Redundant 100~240V AC/36-60V DC dual power
- Active-active redundant power failure protection
- Backup of catastrophic power failure on one supply
- Fault tolerance and resilience

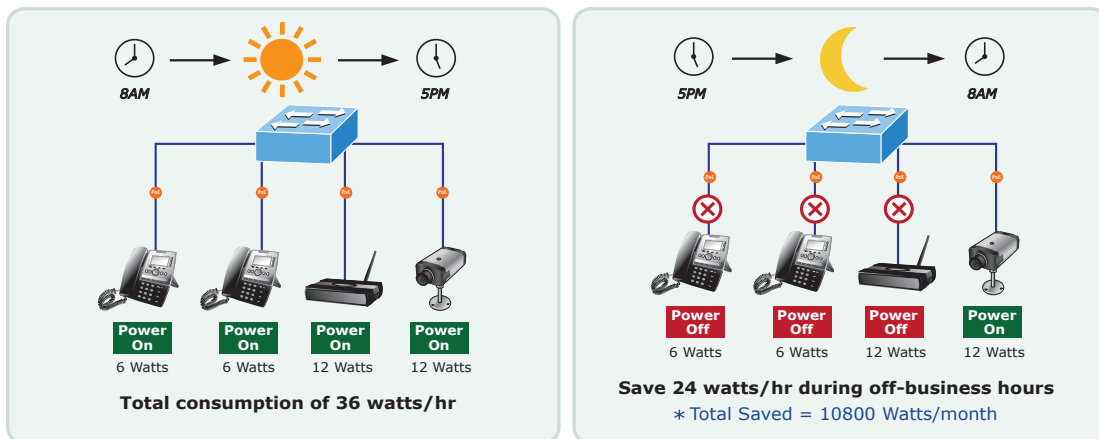

**Robust Layer 2 Features**

The GS-5220 can be programmed for advanced switch management functions such as dynamic port link aggregation, **Q-in-Q VLAN**, private VLAN, **Multiple Spanning Tree Protocol (MSTP)**, Layer 2/4 QoS, bandwidth control and **IGMP/MLD** snooping. The GS-5220 provides 802.1Q tagged VLAN, and the VLAN groups allowed will be maximally up to 256. Via aggregation of supporting ports, the GS-5220 allows the operation of a high-speed trunk combining multiple ports. It enables up to 14 groups of 8 ports for trunk maximum and supports connection fail-over as well.

**Powerful Security from Layer 2 to Layer 4**

The GS-5220 offers comprehensive Layer 2 to Layer 4 **Access Control List (ACL)** for enforcing security to the edge. It can be used to restrict network access by denying packets based on source and destination IP address, TCP/UDP ports or defined typical network applications. Its protection mechanism also comprises **802.1X Port-based** and **MAC-based** user and device authentication. With the **private VLAN** function, communication between edge ports can be prevented to ensure user privacy.

**Advanced IP Network Protection**

The GS-5220 also provides **DHCP Snooping**, **IP Source Guard** and **Dynamic ARP Inspection** functions to prevent IP snooping from attack and discard ARP packets with invalid MAC address. The network administrators can now construct highly-secure corporate networks with considerably less time and effort than before.

*Efficient Management*

For efficient management, the GS-5220 is equipped with console, Web and SNMP management interfaces.

- With the built-in **Web-based** management interface, the GS-5220 offers an easy-to-use, platform-independent management and configuration facility.
- For **text-based** management, it can be accessed via Telnet and the console port. For reducing product learning time, the GS-5220 offers Cisco-like command and customers do not need to learn new command.
- For standard-based monitor and management software, it offers SNMPv3 connection which encrypts the packet content at each session for secure remote management.

*Intelligent SFP Diagnosis Mechanism*

The GS-5220 supports SFP-DDM (**Digital Diagnostic Monitor**) function that greatly helps network administrator to easily monitor real-time parameters of the SFP, such as optical output power, optical input power, temperature, laser bias current, and transceiver supply voltage.

## Digital Diagnostic Monitor (DDM)

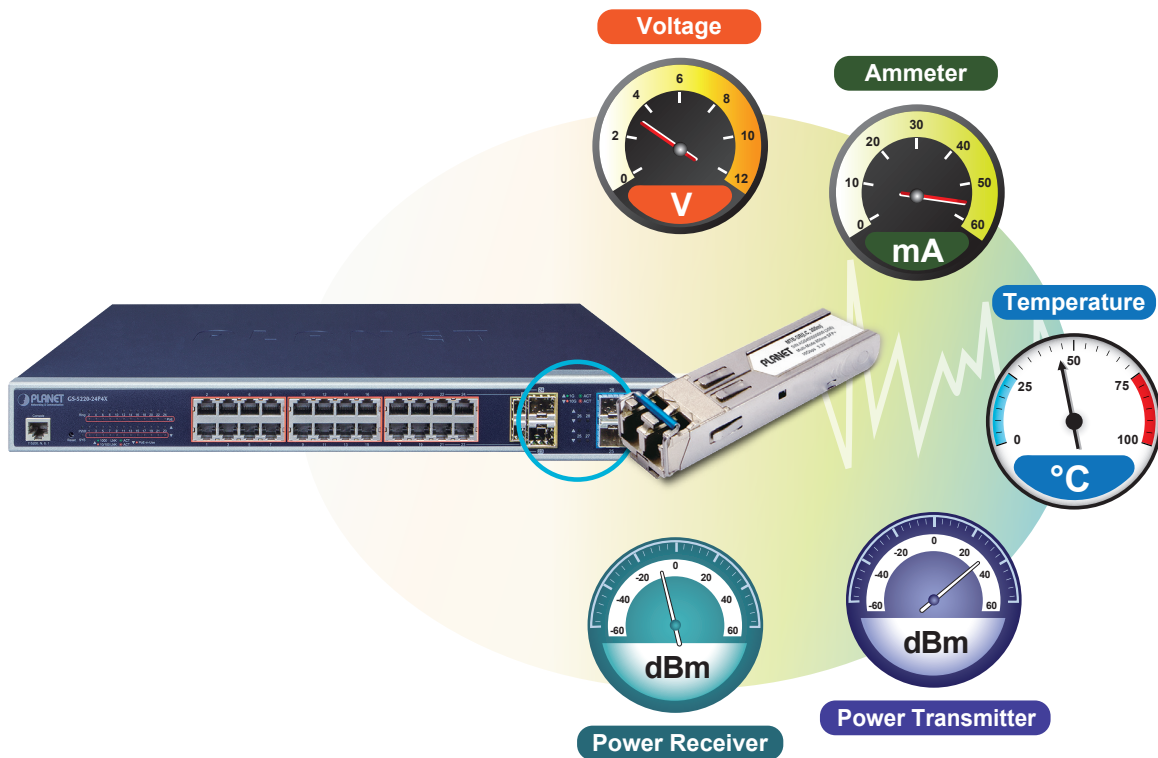

## Applications

### Excellent 10Gbps High Bandwidth Solution to Core Network

The GS-5220 performs 128Gbps non-blocking switch fabric, so it can easily provide a local 10Gbps high bandwidth Ethernet network for the backbone of your department. With the four built-in SFP+ ports, it provides the uplink to the backbone network through the 10G Ethernet SR/LR SFP+ modules. It further improves the network efficiency and protects the network clients by offering the security and QoS features.

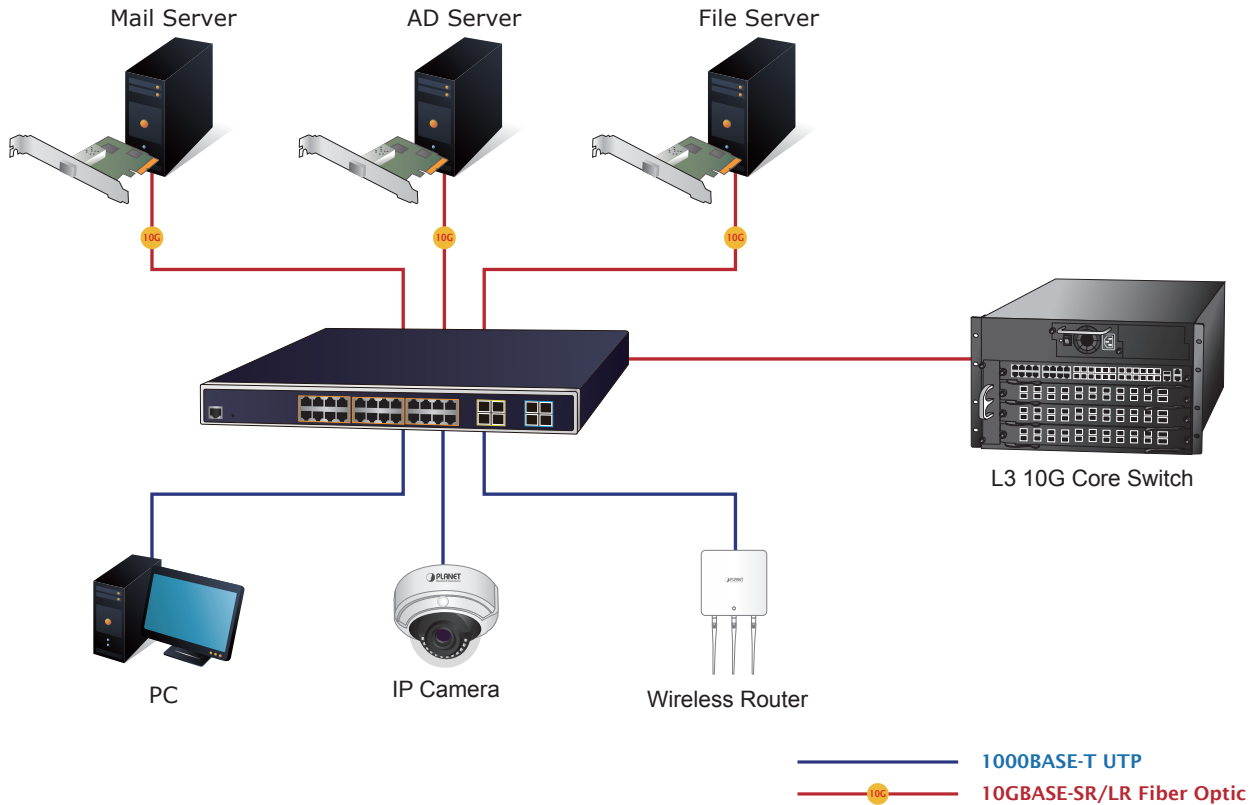

### Layer 3 VLAN Static Routing and PoE Application

The GS-5220 features IEEE 802.3at PoE+ that combines up to 36-watt power output per port, and PoE budget is up to 400 and 600 watts which can deploy up to 24 PoE PD devices. With the built-in robust IPv4/IPv6 Layer 3 traffic routing protocol, the GS-5220 ensures reliable routing between VLANs and network segments. The routing protocols can be applied by VLAN interface with up to 128 routing entries. It is certainly a cost-effective and ideal solution for enterprises.

## Specifications

Product	GS-5220-24P4X	GS-5220-24PL4XR
<b>Hardware Specifications</b>		
Hardware Version	2	
Copper Ports	24 10/100/1000BASE-T RJ45 auto-MDI/MDI-X ports	
SFP/mini-GBIC Slots	4 100/1000BASE-X SFP interfaces, shared with Port-21 to Port-24 Compatible with 100BASE-FX SFP transceiver	
SFP+ Ports	4 10GBASE-SR/LR SFP+ interfaces (Port-25 to Port-28) Compatible with 1000BASE-SX/LX/BX SFP transceiver	
Console	1 x RS232-to-RJ45 serial port (115200, 8, N, 1)	
SDRAM	512MBytes	
Flash Memory	64MBytes	
Reset Button	< 5 sec: System reboot > 5 sec: Factory default	
Dimensions (W x D x H)	440 x 300 x 44.5 mm, 1U height	
Weight	4546g	5071g
Power Consumption	Max. 452 watts/1550.8BTU	AC: Max.661.5 watts/2269.2 BTU DC: Max. 34.5 watts/118.4BTU
Power Requirements – AC	AC 100~240V, 50/60Hz, 8A	AC 100~240V, 50/60Hz, 10A
Power Requirements – DC	--	DC 36~60V, 2A
ESD Protection	6KV DC	
Fan	3 smart fans	
LED	System: SYS (Green) AC/PWR (Green) DC (Green) (GS-5220-24PL4XR Only) Ring (Green) Fan1/2/3 Alert (Red) PoE PWR Alert (Red) PoE Ethernet Interfaces (Port-1 to Port-24): PoE (Orange) Ethernet Interfaces (Port-1 to Port-24): 1000 LNK/ACT (Green), 10/100 LNK/ACT (Orange) 100/1000Mbps SFP Combo Interfaces (Port 21 to Port 24): 1000 (Green), 100 (Orange) 1/10G SFP+ Interfaces (Port-25 to Port-28) : 1G (Green), 10G (Orange)	
<b>Switching Specifications</b>		
Switch Architecture	Store-and-Forward	
Switch Fabric	128Gbps/non-blocking	
Throughput	95.23Mpps@64Bytes	
Address Table	16K entries, automatic source address learning and aging	
Shared Data Buffer	32M bits	
Flow Control	IEEE 802.3x pause frame for full duplex Back pressure for half duplex	
Jumbo Frame	10K bytes	
<b>Power over Ethernet</b>		
PoE Standard	IEEE 802.3at PoE+ PSE	
PoE Power Supply Type	End-span	
PoE Power Output	36 watts (max.)	
Power Pin Assignment	End-span : 1/2(-), 3/6(+)	
PoE Power Budget	400 watts (max.)	600 watts (max.)
PoE Ability PD @ 7 watts	24 units	24 units
PoE Ability PD @ 15.4 watts	24 units	24 units
PoE Ability PD @ 30.8 watts	12 units	20 units
<b>Layer 3 Functions</b>		
IP Interfaces	Max. 128 VLAN interfaces	
Routing Table	Max. 128 routing entries	
Routing Protocols	Ipv4 OSPFv2 Ipv4 hardware static routing Ipv6 hardware static routing	

Layer 2 Management Functions	
Port Configuration	Port disable/enable Auto-negotiation 10/100/1000Mbps full and half duplex mode selection Flow control disable/enable
Port Status	Display each port's speed duplex mode, link status, flow control status, auto-negotiation status, trunk status
Port Mirroring	TX/RX/Both Many-to-1 monitor
VLAN	IEEE 802.1Q tagged VLAN IEEE 802.1ad Q-in-Q tunneling Private VLAN Edge (PVE) MAC-based VLAN Protocol-based VLAN Voice VLAN MVR (Multicast VLAN registration) Up to 4K VLAN groups, out of 4095 VLAN IDs
Link Aggregation	IEEE 802.3ad LACP/static trunk 14 groups with 8 port per trunk
Spanning Tree Protocol	IEEE 802.1D Spanning Tree Protocol (STP) IEEE 802.1w Rapid Spanning Tree Protocol (RSTP) IEEE 802.1s Multiple Spanning Tree Protocol (MSTP)
IGMP Snooping	IPv4 IGMP (v1/v2/v3) snooping IPv4 IGMP querier mode support Up to 255 multicast groups
MLD Snooping	IPv6 MLD (v1/v2) snooping IPv6 MLD querier mode support Up to 255 multicast groups
Bandwidth Control	Per port bandwidth control Ingress: 100Kbps~1000Mbps Egress: 100Kbps~1000Mbps
QoS	Traffic classification based, strict priority and WRR 8-level priority for switching: - Port number - 802.1p priority - 802.1Q VLAN tag - DSCP/ToS field in IP packet
Ring	Supports ERPS, and complies with ITU-T G.8032 Recovery time < 10ms@ 3 units Recovery time < 50ms@16 units
Security Functions	
Access Control List	IP-based ACL/MAC-based ACL ACL based on: - MAC Address - IP Address - Ethertype - Protocol Type - VLAN ID - DSCP - 802.1p Priority Up to 256 entries
Security	Port security IP source guard Dynamic ARP inspection Command line authority control based on user level
AAA	RADIUS client TACACS+ client
Network Access Control	IEEE 802.1x port-based network access control MAC-based authentication Local/RADIUS authentication
Security Functions	
Basic Management Interfaces	Console Telnet Web browser SNMP v1, v2c



Secure Management Interfaces	SSHv2, TLS v1.2, SNMPv3
System Management	Firmware upgrade by HTTP protocol through Ethernet network Configuration upload/download through HTTP Remote Syslog System log LLDP protocol NTP PLANET Smart Discovery Utility
SNMP MIBs	RFC 1213 MIB-II RFC 1493 Bridge MIB RFC 1643 Ethernet MIB RFC 2863 Interface MIB RFC 2665 Ether-Like MIB RFC 2819 RMON MIB (Groups 1, 2, 3 and 9) RFC 2737 Entity MIB RFC 2618 RADIUS Client MIB RFC 2863 IF-MIB RFC 2933 IGMP-STD-MIB RFC 3411 SNMP-Frameworks-MIB RFC 4292 IP Forward MIB RFC 4293 IP MIB RFC 4836 MAU-MIB IEEE 802.1X PAE LLDP
<b>Standards Conformance</b>	
Regulatory Compliance	FCC Part 15 Class A, CE
Standards Compliance	IEEE 802.3 10BASE-T IEEE 802.3u 100BASE-TX/100BASE-FX IEEE 802.3z Gigabit SX/LX IEEE 802.3ab Gigabit 1000T IEEE 802.3ae 10Gb/s Ethernet IEEE 802.3x flow control and back pressure IEEE 802.3ad port trunk with LACP IEEE 802.1D Spanning Tree Protocol IEEE 802.1w Rapid Spanning Tree Protocol IEEE 802.1s Multiple Spanning Tree Protocol IEEE 802.1p Class of Service IEEE 802.1Q VLAN tagging IEEE 802.1x Port Authentication Network Control IEEE 802.1ab LLDP IEEE 802.3af Power over Ethernet IEEE 802.3at Power over Ethernet Plus RFC 768 UDP RFC 793 TFTP RFC 791 IP RFC 792 ICMP RFC 2068 HTTP RFC 1112 IGMP v1 RFC 2236 IGMP v2 RFC 3376 IGMP v3 RFC 2710 MLD v1 RFC 3810 MLD v2 RFC 2328 OSPF v2 ITU-T G.8032 ERPS Ring
<b>Environment</b>	
Operating	Temperature: 0 ~ 50 degrees C Relative Humidity: 5 ~ 95% (non-condensing)
Storage	Temperature: -10 ~ 70 degrees C Relative Humidity: 5 ~ 95% (non-condensing)

## Ordering Information

GS-5220-24P4X	L3 24-Port 10/100/1000T 802.3at PoE+ 4-Port 10G SFP+ Managed Switch
GS-5220-24PL4XR	L3 24-Port 10/100/1000T 802.3at PoE+ 4-Port 10G SFP+ Managed Switch with System Redundant Power (600W)

## Related PoE Products

GS-5220-16UP4S2XR	L2+ 16-Port 10/100/1000T 802.3bt PoE + 4-Port 100/1000X SFP + 2-Port 10G SFP+ Managed Switch with System Redundant Power
GS-5220-24UP4XR	L2+ 24-Port 10/100/1000T 802.3bt PoE + 4-Port 10G SFP+ Managed Switch with System Redundant Power
GS-5220-24P4XV	L2+ 24-Port 10/100/1000T 802.3at PoE+ 4-Port 10G SFP+ Managed Switch with LCD Touch Screen
GS-5220-24P4XVR	L2+ 24-Port 10/100/1000T 802.3at PoE+ 4-Port 10G SFP+ Managed Switch with LCD Touch Screen and Redundant Power
GS-5220-24UP4XV	L2+ 24-Port 10/100/1000T 802.3bt PoE + 4-Port 10G SFP+ Managed Switch with LCD Touch Screen
GS-5220-24UPL4XVR	L2+ 24-Port 10/100/1000T 802.3bt PoE + 4-Port 10G SFP+ Managed Switch with LCD Touch Screen and Redundant Power

## Available 10Gbps Modules

CB-DASFP-0.5M	10G SFP+ Directly-attached Copper Cable (0.5m in length)
CB-DASFP-2M	10G SFP+ Directly-attached Copper Cable (2m in length)
MTB-SR	10GBASE-SR mini-GBIC module - 300m
MTB-LR	10GBASE-LR mini-GBIC module - 10km
MTB-LA20	10GBASE-LX (WDM,TX:1270nm) mini-GBIC module - 20km
MTB-LB20	10GBASE-LX (WDM,TX:1330nm) mini-GBIC module - 20km
MTB-LA40	10GBASE-LX (WDM,TX:1270nm) mini-GBIC module - 40km
MTB-LB40	10GBASE-LX (WDM,TX:1330nm) mini-GBIC module - 40km
MTB-LA60	10GBASE-LX (WDM,TX:1270nm) mini-GBIC module - 60km
MTB-LB60	10GBASE-LX (WDM,TX:1330nm) mini-GBIC module - 60km

## Available 1000Mbps Modules

MGB-GT	SFP-Port 1000BASE-T Module
MGB-SX	SFP-Port 1000BASE-SX mini-GBIC module - 220/550m
MGB-LX	SFP-Port 1000BASE-LX mini-GBIC module - 20km
MGB-L40	SFP-Port 1000BASE-LX mini-GBIC module - 40km
MGB-L80	SFP-Port 1000BASE-LX mini-GBIC module - 80km
MGB-L120	SFP-Port 1000BASE-LX mini-GBIC module - 120km
MGB-LA10	SFP-Port 1000BASE-LX mini-GBIC module - 120km
MGB-LB10	SFP-Port 1000BASE-LX (WDM,TX:1310nm) mini-GBIC module - 10km
MGB-LA20	SFP-Port 1000BASE-LX (WDM,TX:1310nm) mini-GBIC module - 20km
MGB-LB20	SFP-Port 1000BASE-LX (WDM,TX:1550nm) mini-GBIC module - 20km
MGB-LA40	SFP-Port 1000BASE-LX (WDM,TX:1310nm) mini-GBIC module - 40km
MGB-LB40	SFP-Port 1000BASE-LX (WDM,TX:1550nm) mini-GBIC module - 40km

## Available 100Mbps Modules

MFB-FX	SFP-Port 100BASE-FX Transceiver (1310nm) - 2km
MFB-F20	SFP-Port 100BASE-FX Transceiver (1310nm) - 20km
MFB-F40	SFP-Port 100BASE-FX Transceiver (1310nm) - 40km
MFB-F60	SFP-Port 100BASE-FX Transceiver (1310nm) - 60km
MFB-FA20	SFP-Port 100BASE-BX Transceiver (WDM,TX:1310nm) - 20km
MFB-FB20	SFP-Port 100BASE-BX Transceiver (WDM,TX:1550nm) - 20km

### PLANET Technology Corporation

11F., No.96, Minquan Rd., Xindian Dist., New Taipei City 231,  
Taiwan (R.O.C.)

Tel: 886-2-2219-9518

Email: sales@planet.com.tw

Fax: 886-2-2219-9528

www.planet.com.tw



### GS-5220-24P4X/GS-5220-24PL4XR

PLANET reserves the right to change specifications without prior notice. All brand names and trademarks are property of their respective owners. Copyright © 2021 PLANET Technology Corp. All rights reserved.